



ADA Compliant
Self-Closing

Model S4H-3

Order Verification Form

SIDE MOUNT HANDLE

CUSTOMER,

VERIFICATION MUST BE RECEIVED BEFORE
ORDER CAN BE ENTERED FOR SHIPMENT.

PLEASE SIGN TO VERIFY
S4H-3 FT. BURY
MEETS YOUR REQUIREMENTS.

Customer Signature

Please print name and return to
Woodford Mfg. FAX: 800-765-4115
Email: Sales@WoodfordMfg.com

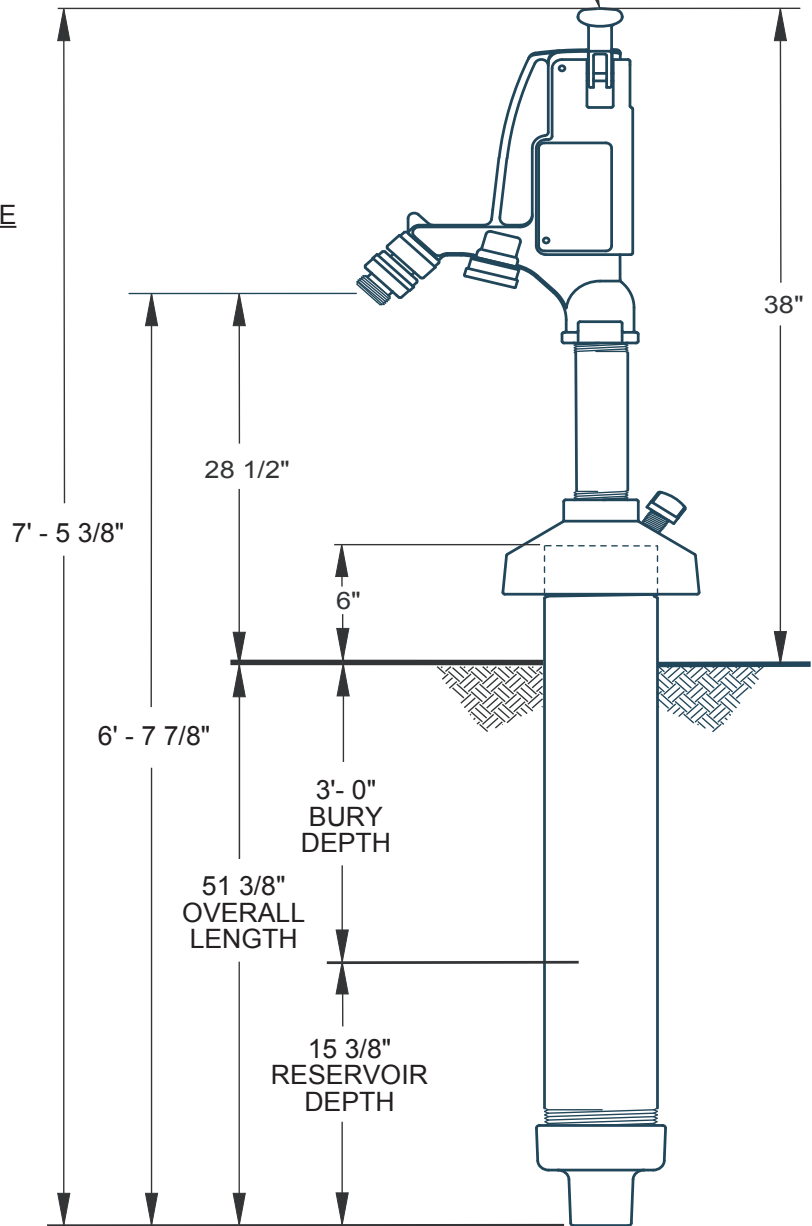

WOODFORD MANUFACTURING COMPANY

Sales Office:
2121 Waynoka Road, Colorado Springs, Colorado 80915

Phone:
(800) 621-6032 Fax: (800) 765-4115